

(D) Montageanleitung

(GB) Assembly instructions

(CZ) Montážní návod

(SK) Návod na montáž

(FR) Notice de montage

(IT) Istruzioni di montaggio

(HU) Szerelési útmutató

(RU) Инструкцији де монтаж

(NL) Handleiding voor de montage

(PL) Instrukcja montażu

(TR) Montaj talimatı

(RU) Инструкция по монтажу



# "KATALIA"

## Łoże 160; 180

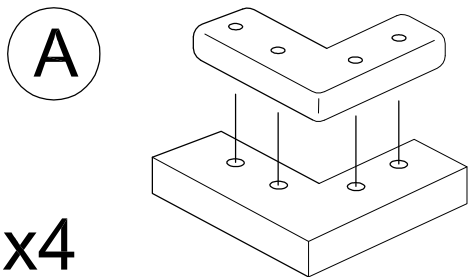
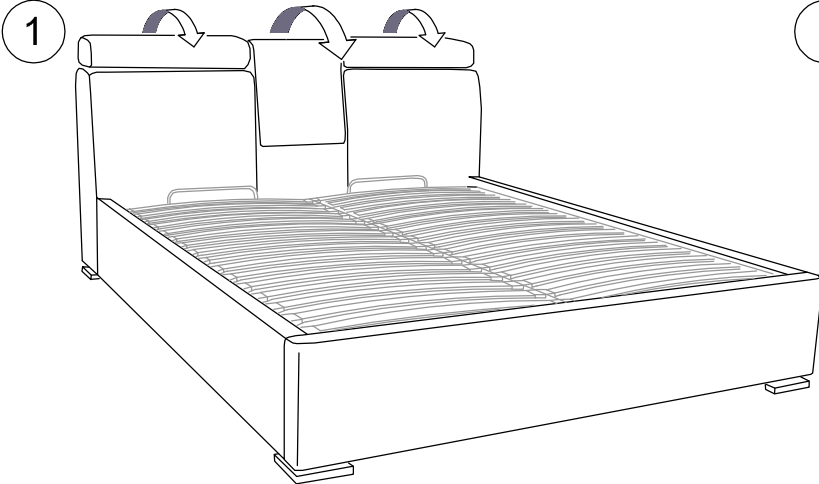
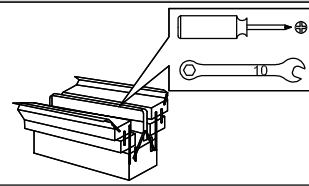

x4

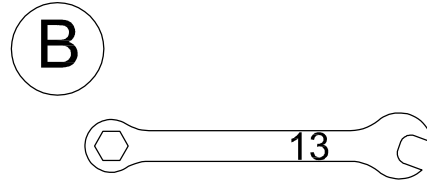

x1

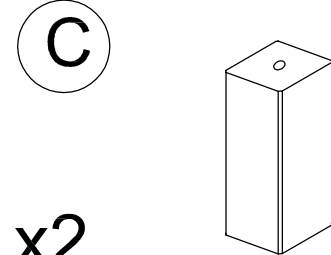

x2

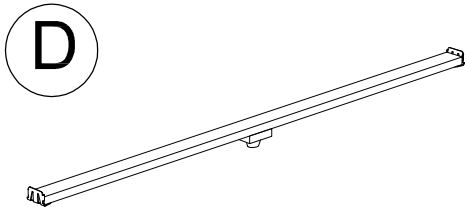

x1

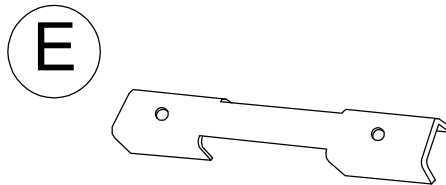

x2

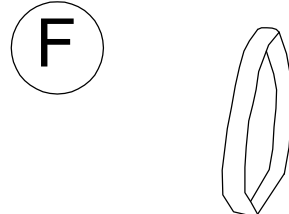

x1

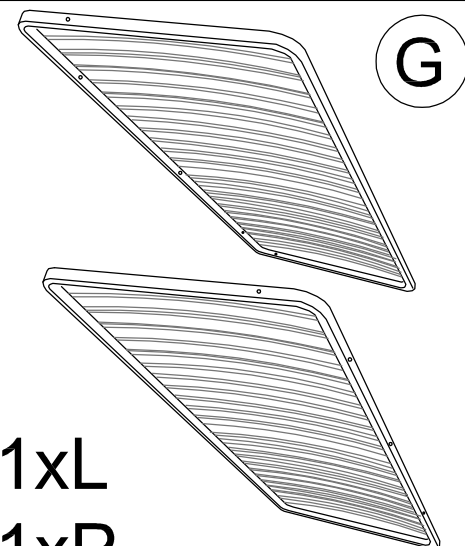

1xL  
1xP

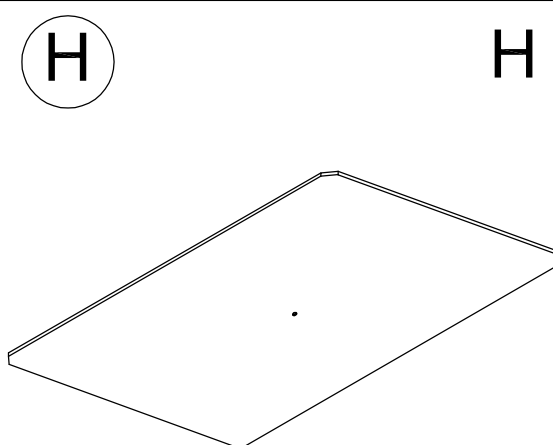

x2

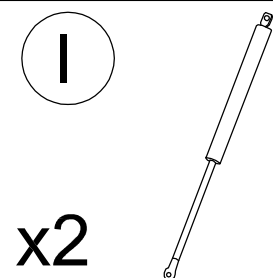

x2



x3

**K** M8x35

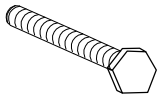

x4

**L** M6x70

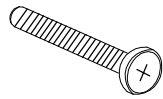

x12

**M** 4x40

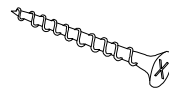

x2

**N** M6x35

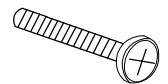

x4

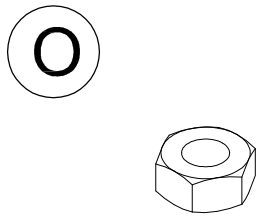

M6x4  
M8x3

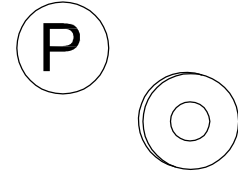

M6x4  
M8x3

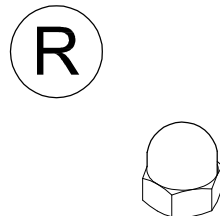

x4

